

## SYSTEM SPECIFICATIONS

Minimum width	770mm
Maximum width	3600mm
Maximum drop	3000mm
Maximum area	10sqm
Linkable	No
Headbox	Yes
Fabric deductions	N/A zipper to edges

## TECHNICAL INFORMATION

Headbox	Two part extruded aluminium headbox 100x120mm
End plates	Cast aluminium with channel connection lug
Roller tube	65mm roller tube
Zip channels	Two part extruded aluminium channels 35x50mm
Installation options	Reveal or face fix installation variations

## System details

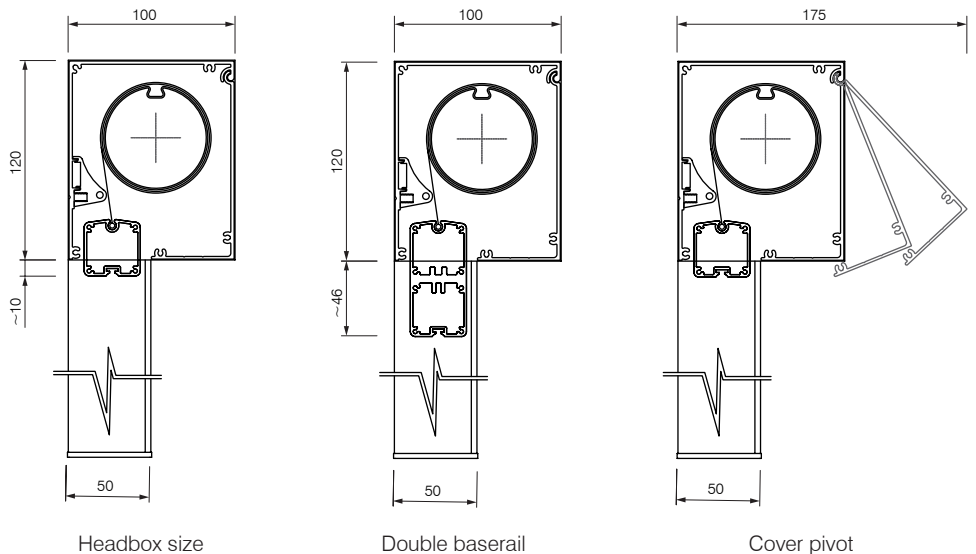

## Zip channel & baserail sizes

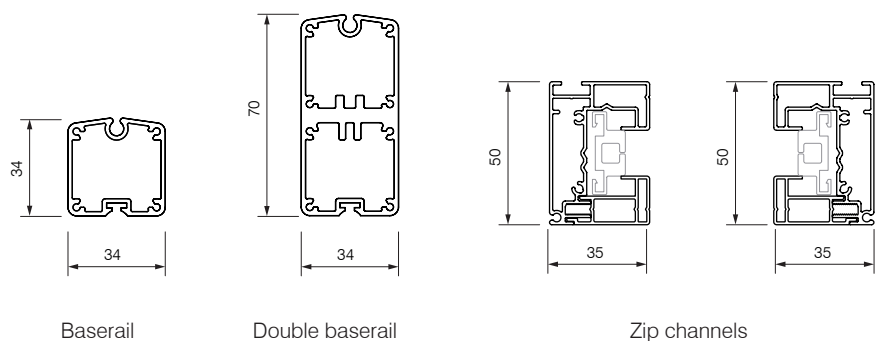

# HMX 100 ZIP

## EXTERNAL ZIP BLIND 100x120mm HEADBOX



The Helioscreen **HMX 100 ZIP** is a unique and versatile external blind system.

The zip guide channels hold the fabric laterally, removing gaps between the channel and the fabric, which increases stability and visual appeal.

Designed and engineered in Europe, this system features a discreet and compact 100x120mm headbox and allows many installation variations, including concealment within a top recess.

## Fixing options

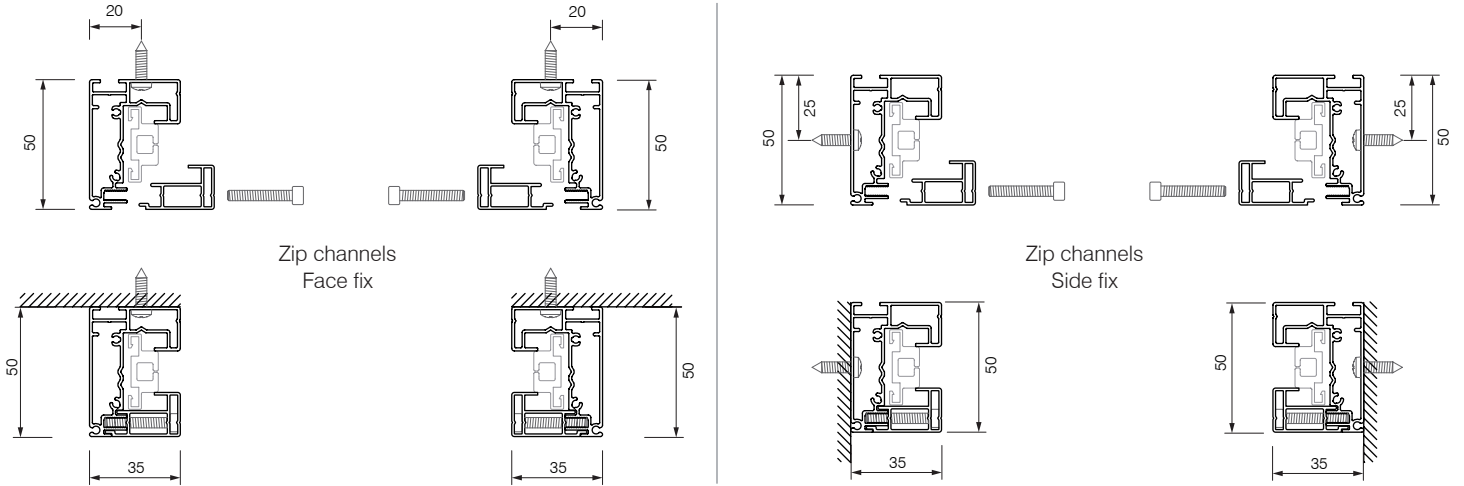

## Power cable exit options

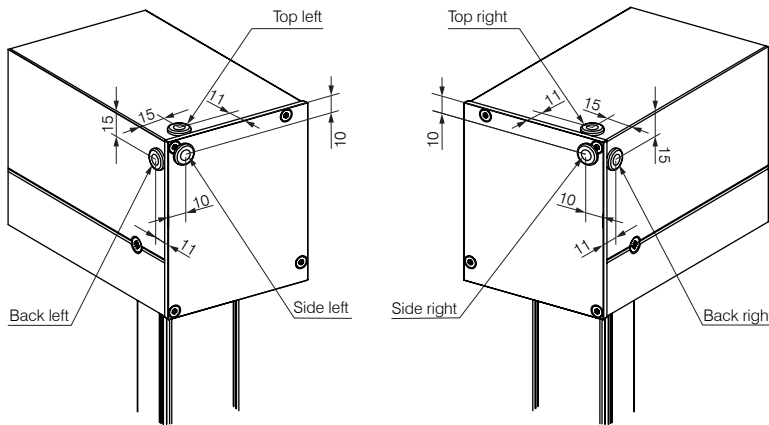

## HMX 100/R (Recess detail)

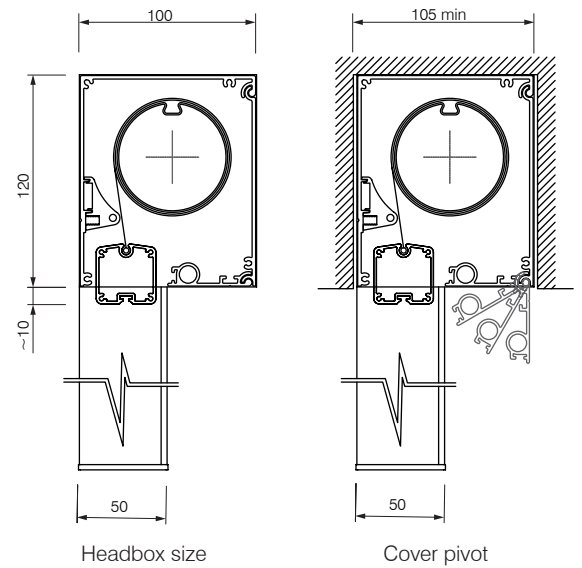

## Zip channel stand-off brackets – detail

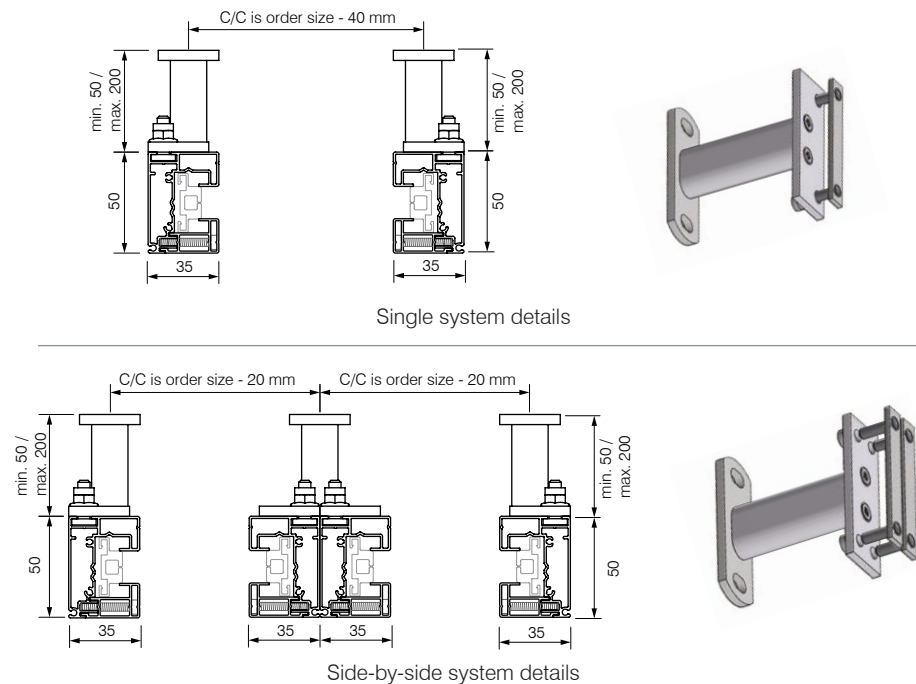

## Side view

